

THE MECHANICAL EQUIPMENT

BY

JOSEPH W. ROE, M.E.

*Assistant Professor Mechanical Engineering Sheffield
Scientific School, Yale University*

VOLUME 3

FACTORY MANAGEMENT COURSE

INDUSTRIAL EXTENSION INSTITUTE
INCORPORATED
NEW YORK

△

HD 5000



Copyright, 1918, by
INDUSTRIAL EXTENSION INSTITUTE
INCORPORATED

CHAPTER XXV

BOOT AND SHOE MACHINERY

General Characteristics.—The machines used in making boots and shoes are quite unlike those which are to be found in other lines of manufacture. The difference is due to the nature of the principal material used, to the small size of the parts composing the shoe, and to the kinds of operation performed. In general, shoe machines translate into mechanical processes the manual dexterity of the old-fashioned shoemaker in using the hammer, knife, awl, and needle. The fundamental machines, most of them developed by clever shoemakers, were original in design, and even those now used for pressing, rolling, grinding and buffing are distinctive, for they do not closely resemble the corresponding machinery in wood or metal-working, although they perform the same operations.

History of Shoe Machinery.—The first important shoe machine, which was invented in 1815, made wooden pegs for fastening the soles of shoes to the uppers. In 1845 the rolling machine was introduced, for compressing and hardening sole leather; this mechanical process replaced the hand hammering which had been in vogue up to that time. In 1851 a Lynn shoemaker, by the name of Nichols, adopted

Howe's sewing machine to sewing shoe uppers, and a year later the machine was used in the manufacture of shoes by John Wooldredge, also of Lynn. The introduction of this machine made shoe manufacture distinctly a factory industry. In 1858 Lyman R. Blake, another shoemaker, invented a machine for sewing uppers and soles together, which was improved by Mathies and built by Gordon McKay, a capitalist and manufacturer. It was first used commercially in 1861, and now the name McKay is given to one of the most widely manufactured types of shoe in this country.

A still more important advance was made in 1862, when Auguste Destouy, a New York mechanic, invented a machine with a curved needle for sewing the soles of turn shoes. This was developed under the direction of Charles Goodyear, son of the inventor of the vulcanizing process, and in 1875 was applied to the sewing of welts to insoles in the manufacture of "Goodyear welt" shoes, which are superior to all other types in comfort, wearing quality, and appearance. The manufacture of the rougher grades was made materially easier by the commercial application, in 1857, of a pegging machine for driving the wooden pegs that hold together the insole, upper, and outsole in pegged shoes.

The first successful lasting machine, the invention of a Boston lawyer, George Coneland, was exhibited at the Centennial Exposition, in 1876. A machine duplicating the hand method of lasting was invented in 1883 by Matzeliger, an expert machinist who came to Lynn from Dutch Guiana and learned the shoe

trade. These two machines eliminated the only remaining hand process in shoe manufacture: that of stretching the upper over the last and securing it temporarily by nails, until the sole was attached. These machines have been supplemented by the pulling-over machine, which prepares the shoe for lasting. A recent invention is the clicking machine, for cutting uppers from the hide or skin; it takes the place of the workman with his patterns and knife, who was known as the hand cutter.

Machine Operations.—The principal operations performed in shoe manufacture are: cutting, bending and stretching, and stitching. Among the machines for the first of these operations are clicking machines, stripping machines for cutting hides into strips of a width equal to the length of the sole, sole-cutting or “dieing-out” machines, splitting machines, channelers, skiving machines, edge setters, and so on. Some of these work on the principle of the punch, others use either rotary or stationary knives, while still others use revolving cutters similar to milling cutters. Some of the machines for the second class of operations are sole-laying and sole-leveling machines for bending the sole to the proper shape, channel-opening and channel-laying machines for raising and flattening the channels on insoles, and pulling-over and lasting machines for stretching the uppers over the lasts. The third group is made up of sewing machines of different types, some of which—such as the McKay sewing machine, the Goodyear welt, and the Goodyear outsole rapid-lockstitch machine—stand as landmarks in the development of shoe machinery.

Other operations performed by special machines are rolling, hammering, pressing, nailing, cementing, ironing, grinding, buffing and polishing.

Arrangement of a Shoe Factory.—The modern shoe factory is composed of six departments: for cutting, stitching, stock fitting, “making” or bottoming, finishing and treeing, and for packing and shipping. The cutting and stitching rooms are usually on the top floor, and the sole leather room is generally on the ground floor. The bottoming room is on the floor next below the cutting and stitching departments, and the shipping room is generally on the floor next above the sole-leather room.

Types of Shoes.—The methods now in use for fastening the upper to the sole are: (a) McKay, (b) Goodyear welt, (c) Turned, (d) Standard screw, (e) Pegged.

Figure 181 shows these methods. In the McKay sewed shoe method, a, the upper and the lining are held in the insole by a row of tacks driven from the outsole side and clinched at the points; the outsole is then stitched on using a single thread and chain stitch, the channel being opened up during the stitching and closed or “laid” after the stitching is completed. Sometimes an additional seam, known as “fair stitching,” is run around the outsole close to the edge in imitation of the Goodyear welt. This method is comparatively cheap, but leaves a row of nail points and a seam of heavy thread inside the shoe; moreover, when it is used it is also impossible to put on a new outsole without sewing through to the inside—a stitch difficult to make by hand.

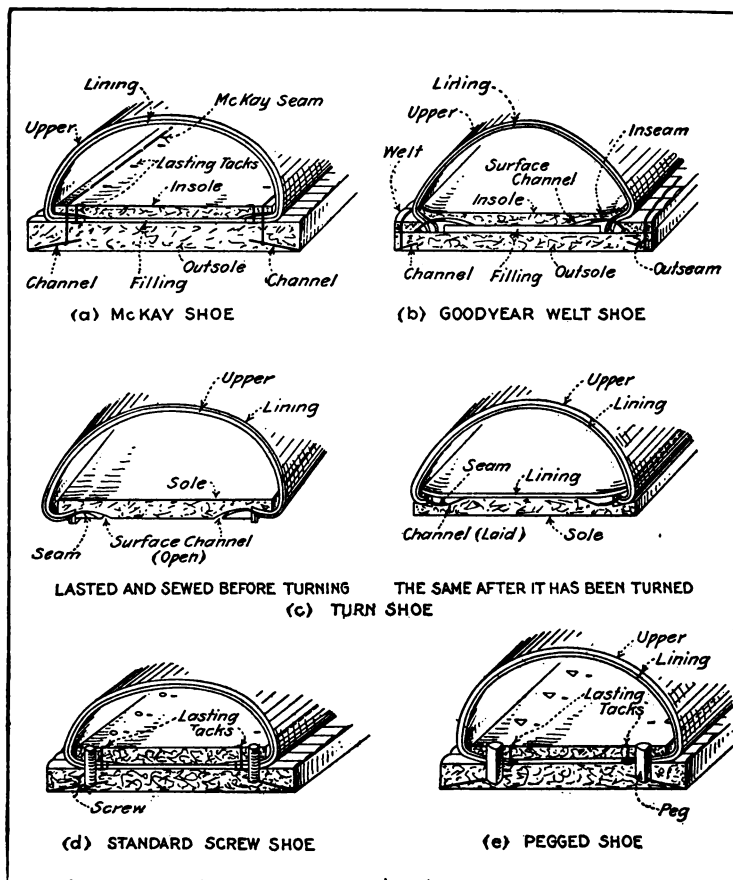

FIG. 181. TYPES OF SOLE FASTENINGS

The Goodyear welt derives its name from the strip or welt of leather which runs around the outsole between the upper and the edge of the sole, uniting the insole, upper leather and outsole by the two rows of stitching shown in the figure. Although appa-

rently complicated, the processes of this method are easily carried out by machinery, and they produce the most comfortable and durable type of shoe. Furthermore, the outsoles can be easily repaired either by hand or by machine.

Turn shoes, *c*, are sewed together inside out; the stitch used is similar to the inseam stitch of a welt shoe. The shoe is then turned right side out and the final operations of heeling, and so on, are performed upon it as in the case of other shoes. Turn shoes are very light and flexible, and the inner surface of the sole is smooth and free from nail points or seams of thread. This type of shoe is used for slippers, pumps, and ladies' fine footwear.

Standard screw and pegged shoes resemble the McKay type, in that tacks are used for attaching the upper leather to the insole; in the McKay shoe, however, the outsole is fastened on by threaded wire screws, while in the pegged type pegs of calendered beechwood are used. The standard-screw shoes, which lack the flexibility of sewn soles, are used for heavy, rough wear. Nailed shoes are similar to pegged shoes, except that nails are substituted for the pegs.

In 1909 the relative production of these different types in the United States was McKay, 41.5 per cent; Goodyear welt, 32.3 per cent; turned, 16.3 per cent; standard screw, 7.9 per cent; pegged and nailed, 2 per cent.

Cutting Room Machinery.—The essential parts of the clicking machine (see Figure 182) are a frame carrying a cutting block, *a*, consisting of maple boards set with the grain end on; a vertical plunger,

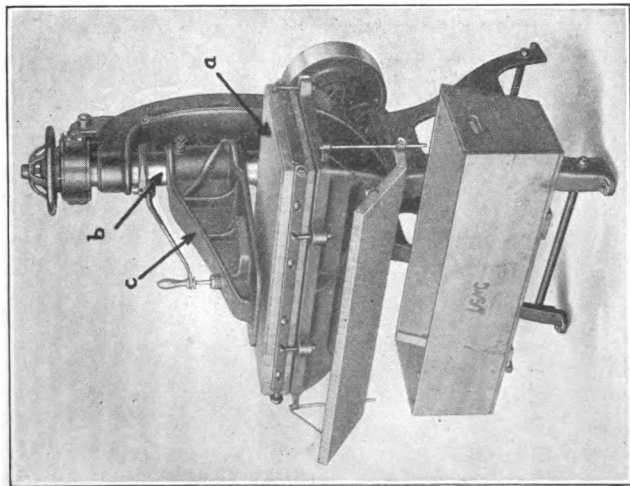

FIG. 182. CLICKING MACHINE

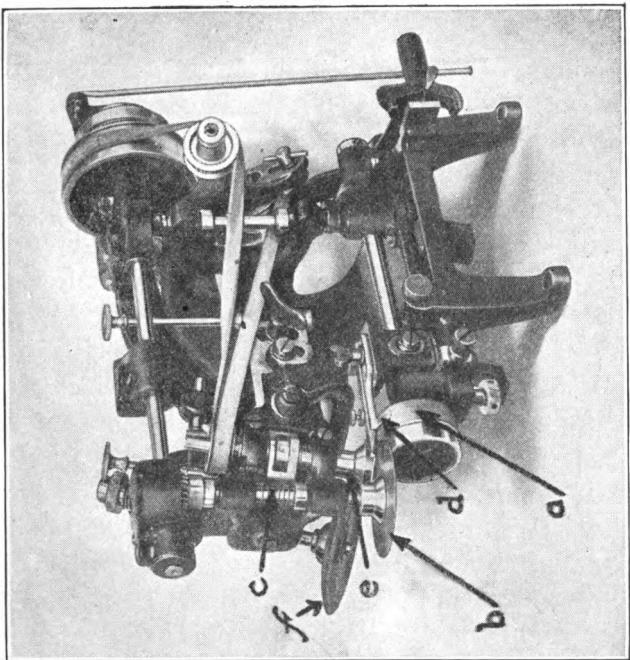

FIG. 183. AMAZEEN MACHINE

United Shoe Machinery Co.

b; and an arm, c, attached to the plunger, which rises and falls with it and may be swung so as to cover any part of the cutting block. The operator places a skin on the block, sets a light steel die or ring, about three-quarters of an inch thick and sharpened on one edge, on that portion of the skin which he wishes to cut out, swings the arm over it, and then forces the die through the leather and a slight distance into the wooden block. It might seem that the continued forcing of sharp dies into the cutting block would roughen it and soon spoil the surface. This is not the case, for the fibres become spongy and elastic because the surface of the block is kept well oiled. This method of cutting against an elastic surface is characteristic of leather manufacture.

The cutting of cloth linings is done in a similar way, but "dieing-out" machines replace the pressure arm of the clicking machine with a strong beam operated by means of eccentrics from a driving shaft below. The larger sizes have cutting blocks 96 inches long, 16 inches wide, and 10 inches high, and are capable of cutting fifty thicknesses of lining at a stroke. Clicking machines do not require such strong construction, since the operator cuts only one thickness of leather owing to the fact that he must select the best parts of each skin and place his dies to leave a minimum amount of scrap.

The skiving machine bevels or scarfs the upper leather to a thin edge, after which cement is applied to the beveled surface and the edge is folded back upon itself and pressed into place so that nothing but the grain side shows. The Amazeen machine,

Figure 183, has a feeding device, made up of a knurled roll, a, and a smooth disk, b, at right angles to it and forced against the upper surface of the feed roll by a helical spring, c. An adjustable guide, d, holds the right-hand edge of the leather at the proper point as it passes backward between the feed roll and the feed disk; a rotary disk-knife, set directly back of the feed on an inclined shaft, e, can be adjusted for various amounts of bevel; and a grinding wheel, f, mounted behind the knife, can be brought into action so as to grind the knife without removing it from the machine. For heavier work machines are used which are similar to this except that they have a stationary knife.

The skived edges are cemented on the top of a box-shaped bench machine. This has a small metal wheel with roughened surface projecting through a slot in the top which supplies the cement to the work. The inside of the machine is a cement reservoir, the adhesive being fed by a screw pump to a well under the wheel, which overflows at a fixed level so that the wheel cannot be flooded.

After being cemented, the edges are turned or folded on a machine of which there are two types. In the "Boston," the leather is laid on the table of the machine and is gripped along its entire length, about a half-inch from the edge, between two clamps that have the same curve as this edge; a block, also shaped to this curve, rises past the clamps and then approaches them, thus folding the edge back upon itself. The "Columbia" machine folds and hammers down a short length of the edge, and then feeds the

work a distance equal to the length folded over. This machine is slower than the Boston, but does not require special clamps and blocks for each shape of edge.

Stitching-Room Machinery.—Uppers and linings are stitched on sewing machines which are adaptations of the sewing machine for cloth. The essentials are the frame, the feed, and the stitching mechanism. A C-frame is used, at the upper end of which is the mechanism for moving the needle up and down, while the lower end forms the table on which the work is laid. This table may be flat and flush with the bench, for sewing flat work; or it may be convex and supported 3 to 6 inches above the bench on a vertical post or a horizontal cylinder which is part of the frame. The principal feeds are the "four-motion" and the "rotary." The four-motion consists of a serrated plate set in a slot in the table, which rises to the work, draws it backward the length of one stitch, descends, and returns to its first position; the rotary is a wheel with a serrated edge, which is intermittently rotated by a ratchet and pawl. The work is held against the feeder by a presser foot or a wheel attached to the upper end of the frame.

The stitching mechanism varies according to the kind of stitch made, which may be one- or two-needle, one- or two-thread, chain stitch; one- or two-needle lock stitch; buttonhole stitch, etc. The commonest are the one-needle, one-thread chain stitch (which is strong and elastic, but has a right and a wrong side and pulls out if broken), and the one-needle lock stitch (which has two threads and does not stretch

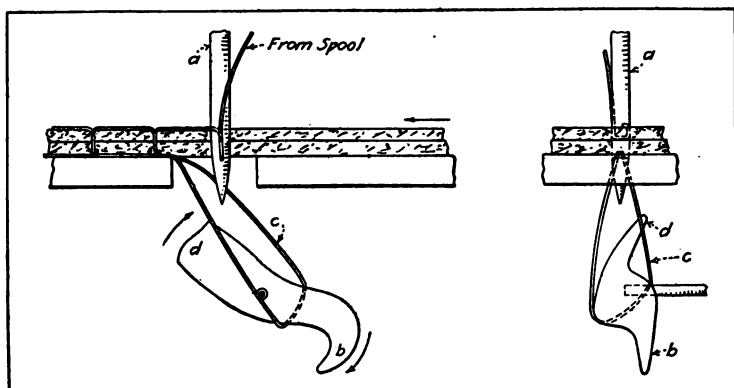

FIG. 184. CHAIN STITCH MECHANISM

easily, but cannot pull out). Figure 184 shows a common chain stitch and the mechanism that forms it. The needle, *a*, descends through the work, carrying the thread with it; the looper, *b*, rotating clockwise, catches a loop of the thread as the needle rises; the work then feeds, the loop *c* is spread laterally so as to encircle the needle on its next descent; and as the needle takes the position shown in the figure, the loop *c* is cast off from *b* by the extension, *d*, and drawn taut as the needle completes its downward stroke. Another method of forming the chain stitch is described later, in connection with the McKay sewing machine.

A typical lock-stitch mechanism, Figure 185, has a needle, *a*, the bobbin inclosed in case *b*, which is supported loosely so that a thread can completely encircle it; the shuttle, *c*, and shuttle driver, *d*, oscillated by shaft *e*. Both *c* and *d* move in a circular path in the frame, *f*. As *a* descends it pulls down a

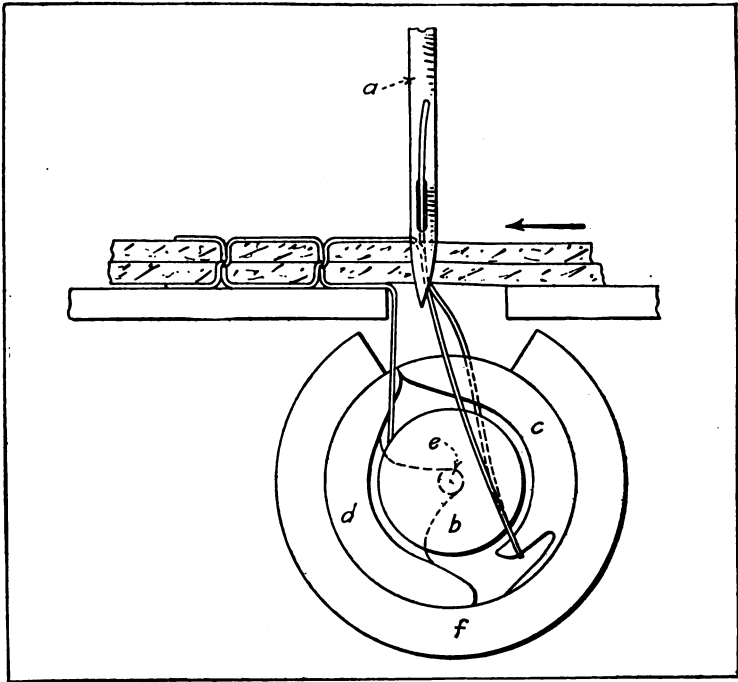

FIG. 185. LOCK STITCH MECHANISM

loop of thread which is caught on the hook of the shuttle, *c*, as it rotates clockwise owing to the pressure from *d*, and is drawn into the position shown. The shuttle rotates slightly farther, while the needle rises and a take-up (not shown) pulls the needle thread off the shuttle hook and over the left side of the bobbin, so as to loop it around the bobbin thread; then *d* reverses its direction, the needle thread passes out through the space opened up by the backlash between *c* and *d*, and further motion of the take-up draws the stitch taut while the shuttle, *c*,

and the driver, *d*, return to their first positions, ready for the next descent of the needle. All stitching devices, either chain stitch or lock stitch, require a tension regulator for the threads; this is usually a pair of discs or plates held together by a thumbscrew and spring, between which the thread is drawn.

The eyeletting, the buttonholing, and the making of the decorative perforations along the upper edges of tips, are also done in the stitching room. The eyeletting machine has a table on which the work is placed, a punch which descends upon the work and perforates it, and an eyelet-placing finger which receives the eyelets from a magazine, one at a time and flanged on one end, and inserts them in the perforations from the under side. A set, or rivetter, descends upon each eyelet and rivets it while the finger holds it in place. The duplex eyeletting machine sets both rows of eyelets on a shoe at the same time; thus perfect alignment is insured.

The buttonholing machine is a special sewing machine which first cuts the buttonhole with a wedge-shaped punch, and then sews it with a two-thread stitch that covers the raw edge of the hole and incloses a cord that protects it. The tip perforations are made either on a "Crown" machine, a bench machine like a miniature sheet-metal punch, which perforates the entire tip at one stroke; or on a "Royal" machine, which has a C-frame like that of a sewing machine, the needle being replaced by a punch which perforates a single hole or unit of the design and simultaneously feeds the work into

position for making the next perforation. The wooden cutting block of the dieing-out machine is replaced by a strip of paper which is fed along under the work.

Machinery of the Stock-Fitting Room.—Stripping machines are used for cutting hides into strips. The individual soles or heel lifts are then cut from the strips on dieing-out machines.

Rolling machines, which compress the sole leather to make it more durable, consist of a housing for an upper and a lower roll, gearing for driving them, a screw adjustment for varying thicknesses of leather, and a treadle for raising the lower roll.

The soles are only roughly cut to shape on the dieing-out machines, which are frequently in a separate factory, so that the accurate form must be obtained on a rounding machine. The "Planet," illustrated in Figure 186, has a circular table, a, on which is mounted a fixture, b, for holding a wooden pattern, c, shaped to the desired form of the sole. The sole is placed between this pattern and a plate, d, which is pressed down from above and is adjustable for different thicknesses of stock. A short vertical knife, e, is held in a block at the end of a swinging arm, g, which is pressed against the pattern by a spring. When the power is applied, the table and the knife rotate rapidly in a counter-clockwise direction for a little more than one revolution, to insure a complete trimming of the surplus material, and then return to their original position. During this interval the knife block has been in continuous contact with the pattern, and has made an exact reproduction in the leather stock.

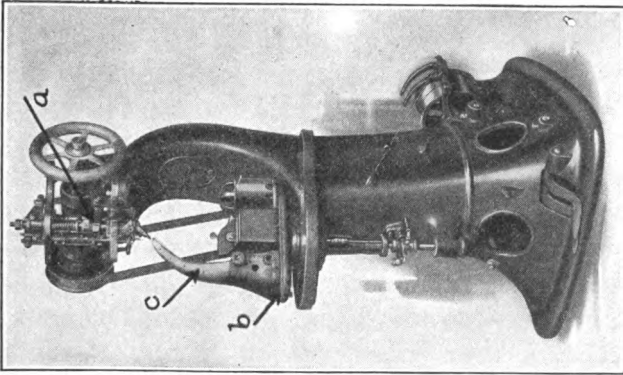

FIG. 188. M'KAY SEWING
MACHINE

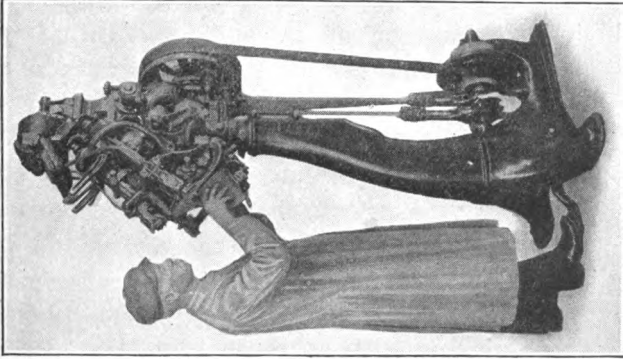

FIG. 187. PULLING-OVER
MACHINE

United Shoe Machinery Co.

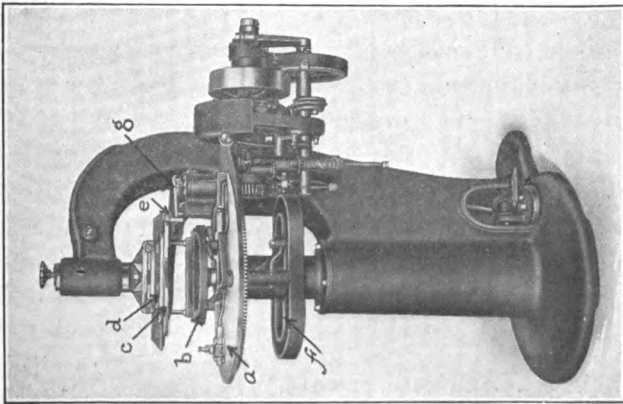

FIG. 186. SOLE-ROUNDING
MACHINE

It always presents the knife edge squarely to the work; and a cam, *f*, shaped roughly to the outline of the sole, helps the spring to keep a uniform pressure of the swinging arm, *g*, against the pattern, and prevents the knife from leaving it when rounding sharp corners.

The channeling of the soles (see Figure 181) is done on machines similar to those used for heavy skiving; the work is fed between rolls against a stationary knife, which is adjusted to cut a slit in the leather instead of shaving off its surface. For Good-year welt insoles two channels are cut simultaneously, one in the outer edge extending toward the center, and the other in the lower surface.

The manufacture of heels has developed into an independent industry. After the lifts, or separate layers, have been cut out the heels are assembled in a heel-building machine, consisting of a horizontal bed on which are set three adjustable guides or jaws, a clamp for holding the lifts together, and a nailing device for driving the required number of nails through them. There is also a cement reservoir and a row of small bins on each side of the bed, for holding sizes of lifts. The operator first places nails in a plunger plate under the bed; he then selects the proper lifts from the bins, dips them into the cement reservoir, and lays them on the bed between the jaws. When a treadle is pressed the jaws are moved together and the lifts are lined up; the power is applied, clamping the lifts together and driving the nails.

Bottoming-Room Machinery.—The machines of this department fall into three classes: lasting machines,

stitching machines, and moulding and leveling machines. Lasting consists of three operations: assembling the upper and the insole upon the last; "pulling over," or drawing the toe part of the upper down over the front end of the insole; and lasting proper, which is a continuation of the pulling-over process all around the sole. Tacking machines first nail the insole to the last and fasten the upper to the last at the heel by two tacks driven part way in. The next operation takes place on the pulling-over machine (Figure 187).

The principal parts of this machine are as follows: adjustable rests for the last and the heel; pincers, one at the toe and the others on each side near the toe; levers for shifting the positions of the pincers by hand after they have gripped the upper, in order that the toe may be exactly centered; devices for drawing the upper over the edge of the last, and for moving the pincers toward each other, thus laying the upper against the bottom of the last; and automatic magazine-fed hammers for driving temporary nails through the upper and the insole. The great advantage of the work of this machine as compared with hand lasting, aside from the saving of time, is that the tension is applied evenly all around the toe rather than at one point at a time, and the workman can see without effort whether the upper is straight and tight before he drives the tacks.

The final lasting is done on a "bed type" machine, the essential feature of which is a pair of wipers at the toe and heel. The shoe is held bottom side up in an adjustable rest; two pairs of plates are then

moved forward, drawing or "wiping" the upper closely around the edge of the sole at the heel and toe. The operator then nails down the upper all around the sole except at the heel, with a rapid-fire tacker, holding the upper with pincers in his left hand while he hammers with his right. The nails are temporary for Goodyear welt and turn soles, but are driven clear in and clinched against an iron plate on the sole of the last in making McKay, standard-screw, and pegged shoes. The wipers are then slid back, and the lasting is complete.

The stitching is done on a McKay, a Goodyear welt, or a Goodyear outsole machine, according to the location of seam and kind of shoe. Figure 188 shows a McKay machine which consists of a head, a, containing the feeding and stitching mechanism, and a turntable, b, which supports the horn, c, and the thread-waxing device, both of which are heated by steam or gas. In operation a shoe, after the last has been removed, is placed upside down on the horn, where it is held by a presser foot, and the stitching mechanism, shown in Figure 189, forms a chain stitch. The thread comes up through the horn, a, Figure 189, and is laid in the barb, c, of the needle by the whorl, b; then the needle rises with a loop of thread while the moving guard, d, is in the dotted position, but when it starts to descend the guard moves to the left and holds the loop in place, so as to enchain the loop that is drawn through from below on the next rise of the needle.

The Goodyear welt machine makes a chain stitch by the same general method, modified in details so

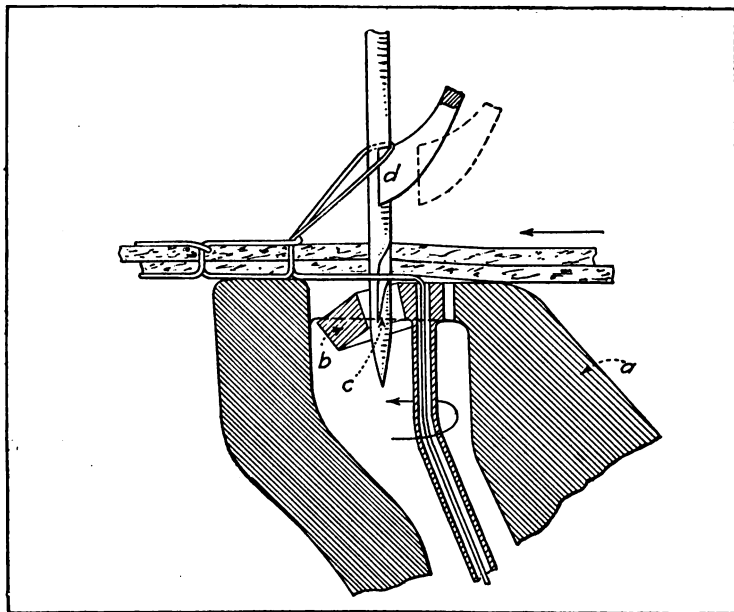

FIG. 189. M'KAY CHAIN STITCH MECHANISM

that a surface stitch (see Goodyear welt in seam, Figure 181, b), instead of a through stitch—is made. Thus the needle is curved instead of straight, and, instead of supporting the shoe on a horn, the operator holds it between a back rest and a guide which enters the surface channel and bears the thrust of the needle. There is also a guide for feeding the welt into position, which can be removed when turn soles are being stitched.

The Goodyear outsole machine makes a lock stitch by a method differing materially from that of the plain sewing machine. Instead of the needle thread's

being fed from above and the shuttle thread from below, their positions are reversed. The needle itself remains on the upper side, being barbed so as to pull the needle thread through from the under side. A reciprocating awl makes the holes, and a take-up lever draws up the slack in the threads after each stitch, duplicating in a clever and very rapid way the work of the old time shoemaker. Other essential parts of the machine, also found on the McKay and Goodyear welt machines, are: (1) steam heating system for the waxed thread, (2) thread-waxer, (3) thread-tension regulator.

Moulding and leveling machines are of two kinds: those which roll the sole, and those which shape it by direct pressure between dies. They are built with two units in tandem, so that the operator can set up one shoe while another is under pressure. The Goodyear sole-leveling machine, of the first type, holds the shoe upside down on a jack, while a concave brass roller is passed back and forth and from side to side over the sole, the pressure being applied by a treadle. The Goodyear sole-laying machine belongs to the direct pressure type; it consists of a lower head surmounted by a rubber die block, and an upper head to which the shoe is attached, the two heads being drawn together by power. The Hercules type combines direct pressure and rolling, by having the shoe-holding jack and the die that shapes the sole swing on pivoted arms, instead of sliding in guides.

Finishing-Room Machinery.—Most of this is typical buffing and polishing equipment: high-speed spindles on which are mounted milling cutters, emery wheels,

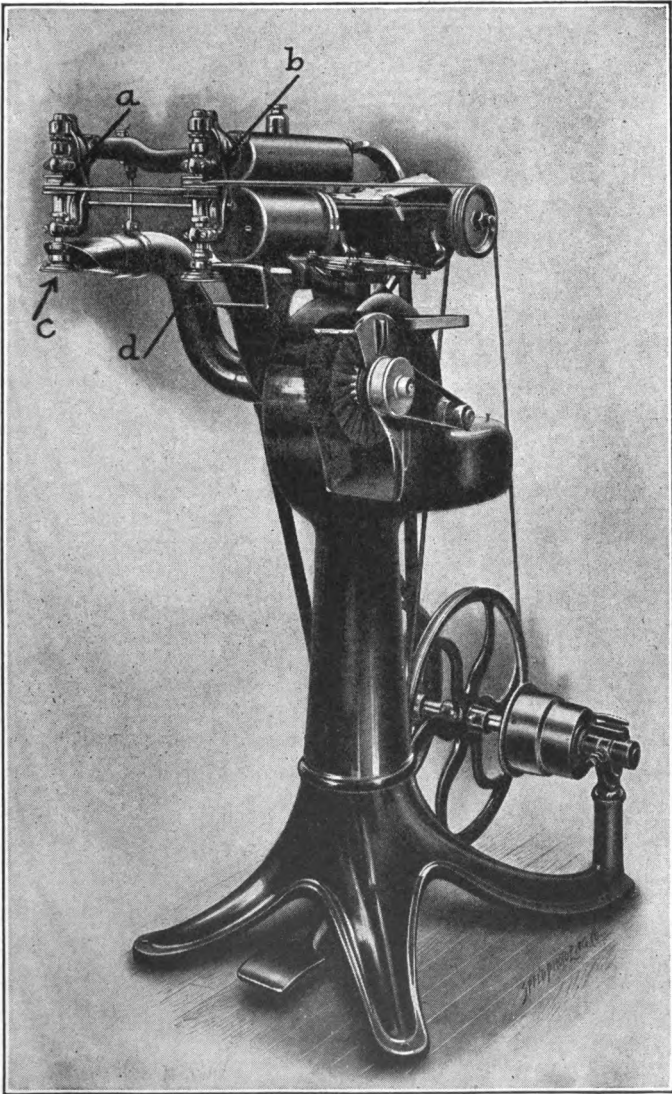

FIG. 190. NAUMKEAG BUFFING MACHINE
United Shoe Machinery Co.

sandpaper wheels, brushes and buffing wheels. The ironing machine is fitted with small blocks or disks of iron, heated by a gas flame, and vibrated or rotated rapidly so as to burnish the surface of the leather. The Naumkeag buffing machine, Figure 190, is in a class by itself. This machine has two vertical spindles, a and b, for rough and fine polishing respectively, at whose lower ends are the emery-covered rubber pads, c, d. These pads are distended by compressed air; thus a delicate, yielding pressure is obtained, and a smooth, velvet surface is given to the work.